

STYN1875

Thyristor Discretes (SCRs)

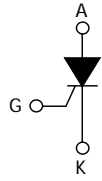
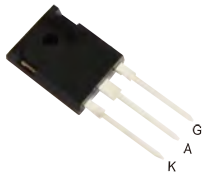

K=Cathode, A=Anode, G=Gate

	V_{RRM} V	V_{RSM} V
STYN1875	1800	1900

Dimensions TO-247AD

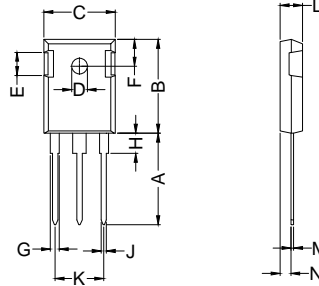

Dim.	Millimeter		Inches	
	Min.	Max.	Min.	Max.
A	19.81	20.32	0.780	0.800
B	20.80	21.46	0.819	0.845
C	15.75	16.26	0.620	0.640
∅D	3.15	3.65	0.124	0.144
E	4.32	5.49	0.170	0.216
F	5.40	6.30	0.213	0.248
G	1.65	2.18	0.065	0.086
H	3.80	4.50	0.150	0.177
J	1.00	1.40	0.039	0.055
K	10.80	11.10	0.425	0.437
L	4.70	5.30	0.185	0.209
M	0.40	0.80	0.016	0.031
N	1.50	2.49	0.059	0.098

Symbol	Test Conditions	Maximum Ratings	Unit	
I_{TRMS} I_{TAVM}	$T_{VJ}=T_{VJM}$ $T_C=85^{\circ}C$; 180° sine	75 48	A	
I_{TSM}	$T_{VJ}=45^{\circ}C$ $V_R=0$ t=10ms (50Hz), sine t=8.3ms (60Hz), sine	540 580	A	
	$T_{VJ}=T_{VJM}$ $V_R=0$ t=10ms(50Hz), sine t=8.3ms(60Hz), sine	480 500		
I^2t	$T_{VJ}=45^{\circ}C$ $V_R=0$ t=10ms (50Hz), sine t=8.3ms (60Hz), sine	1350 1300	A ² s	
	$T_{VJ}=T_{VJM}$ $V_R=0$ t=10ms(50Hz), sine t=8.3ms(60Hz), sine	1050 1030		
$(di/dt)_{cr}$	$T_{VJ}=T_{VJM}$ f=50Hz, $t_p=200\mu s$ $V_D=2/3V_{DRM}$ $I_G=0.3A$ $di_G/dt=0.3A/\mu s$ repetitive, $I_T=75A$	150	A/ μs	
	non repetitive, $I_T=I_{TAVM}$	500		
$(dv/dt)_{cr}$	$T_{VJ}=T_{VJM}$; $R_{GK}=\infty$; method 1 (linear voltage rise) $V_{DR}=2/3V_{DRM}$	1000	V/ μs	
P_{GM}	$T_{VJ}=T_{VJM}$ $I_T=I_{TAVM}$ $t_p=30\mu s$ $t_p=300\mu s$	10 5	W	
		0.5		
P_{GAV}		10	W	
V_{RGM}		10	V	
T_{VJ} T_{VJM} T_{stg}		-40...+140 140 -40...+125	°C	
	M_d	Mounting torque (M3)		0.8...1.2
	F_c	Mounting force with clip		20...120
Weight	typical	6	g	



STYN1875

Thyristor Discretes (SCRs)

Symbol	Test Conditions	Characteristic Values	Unit
I_R, I_D	$T_{VJ}=T_{VJM}; V_R=V_{RRM}; V_D=V_{DRM}$	5	mA
V_T	$I_T=75A; T_{VJ}=25^{\circ}C$	1.60	V
V_{TO}	For power-loss calculations only ($T_{VJ}=125^{\circ}C$)	0.80	V
r_T		11	m Ω
V_{GT}	$V_D=6V;$ $T_{VJ}=25^{\circ}C$ $T_{VJ}=-40^{\circ}C$	1.5 1.6	V
I_{GT}	$V_D=6V;$ $T_{VJ}=25^{\circ}C$ $T_{VJ}=-40^{\circ}C$	100 200	mA
V_{GD}	$T_{VJ}=T_{VJM};$ $V_D=2/3V_{DRM}$	0.2	V
I_{GD}		10	mA
I_L	$T_{VJ}=25^{\circ}C; t_p=10\mu s;$ $I_G=0.3A; di_G/dt=0.3A/\mu s$	150	mA
I_H	$T_{VJ}=25^{\circ}C; V_D=6V; R_{GK}=\infty$	100	mA
t_{gd}	$T_{VJ}=25^{\circ}C; V_D=1/2V_{DRM}$ $I_G=0.3A; di_G/dt=0.3A/\mu s$	2	μs
R_{thJC}	DC current	0.60	K/W
R_{thJH}	DC current	typ. 0.80	K/W
a	Max. acceleration, 50 Hz	50	m/s ²

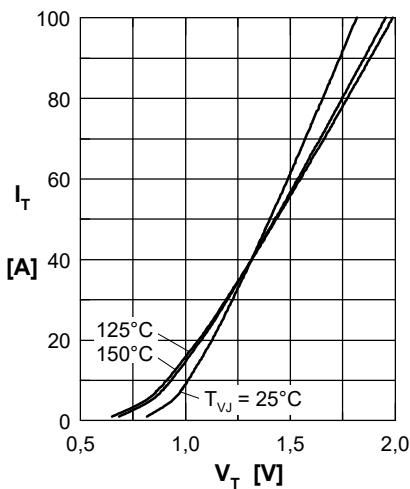

Fig. 1 Forward characteristics

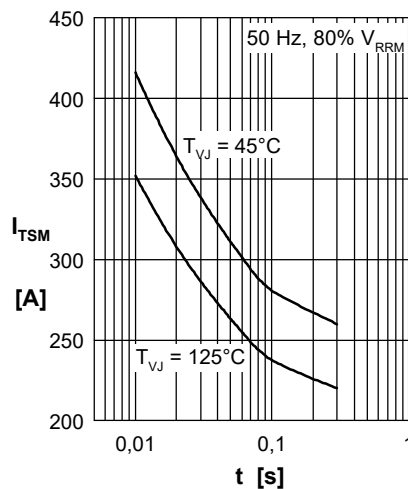

Fig. 2 Surge overload current

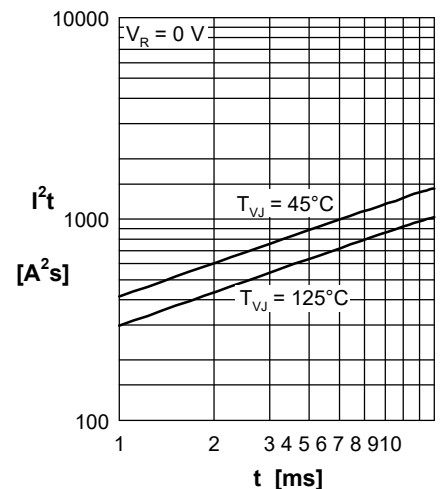

Fig. 3 I^2t versus time (1-10 ms)

STYN1875

Thyristor Discretes (SCRs)

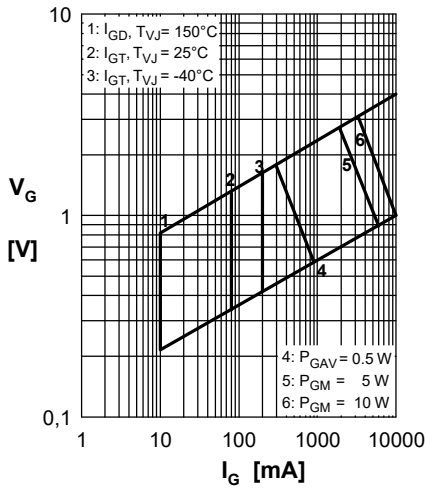

Fig. 4 Gate trigger characteristics

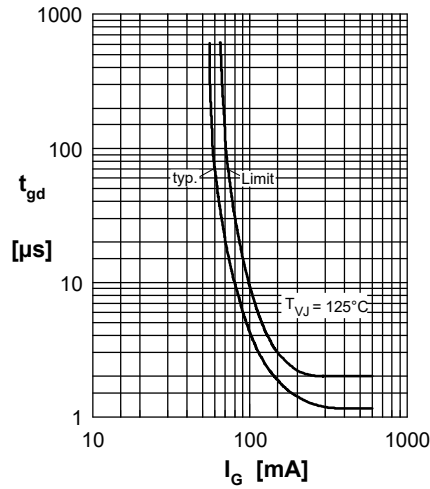

Fig. 5 Gate controlled delay time

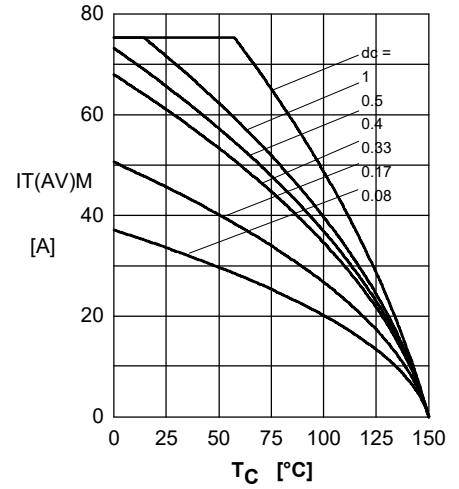

Fig. 6 Max. forward current at case temperature

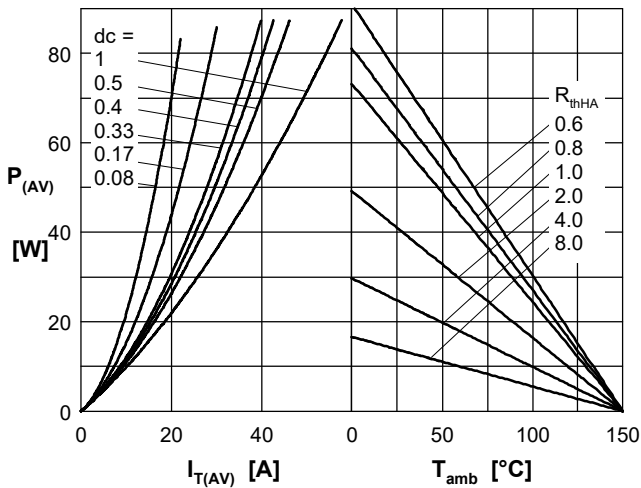

Fig. 7a Power dissipation versus direct output current
Fig. 7b and ambient temperature

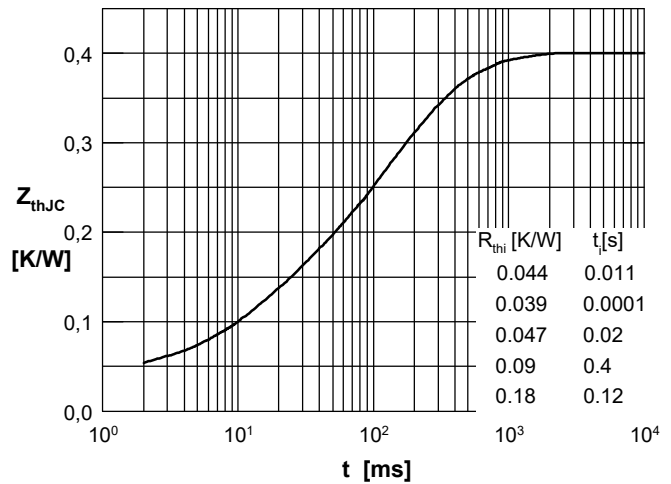
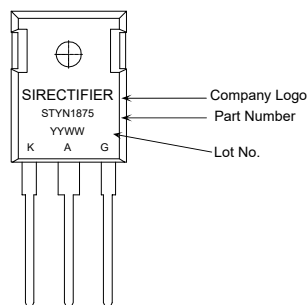

Fig. 8 Transient thermal impedance junction to case

MARKING



ORDERING INFORMATION

Part Number	Package	Shipping	Marking Code
STYN1875	TO-247AD	30pcs / Tube	STYN1875

